

SAFE **T**IMBER **H**ARVESTING



Prepared by:



University of New Hampshire
Cooperative Extension

in cooperation with:

NH Timber Harvesting Council
NH Timberland Owners Association
UNH Thompson School of Applied Sciences

UNH Cooperative Extension Forestry Information Center

Funds for this publication have been provided by the USDA Forest Service and NH Department of Resources and Economic Development, Division of Forests and Lands, in response to the January 1998 ice storm.



University of New Hampshire
Cooperative Extension



Spring 2001

UNH Cooperative Extension programs and policies are consistent with pertinent Federal and State laws and regulations on nondiscrimination regarding race, color, national origin, sex, sexual orientation, age, disability or veteran's status. College of Life Sciences and Agriculture, County Governments, NH Dept. of Resources and Economic Development, Division of Forests and Lands, NH Fish and Game, U.S. Dept. of Agriculture and U.S. Fish and Wildlife Service cooperating.

PREFACE

This guide is not a substitute for proper Safety Training. It is meant as a reference only.

Safety is the responsibility of everyone and should not be placed solely on either management or employees. Management has the responsibility to provide a safe work environment and to properly train employees. Employees have the responsibility to comply with all rules and regulations issued under OSHA.

This Training Guide was originally published by the Forest Industry Safety and Training Alliance, Inc. (FISTA), Rhinelander, Wisconsin in 1997. It is reprinted with permission from FISTA. It has been reviewed by the Occupational Safety and Health Administration (OSHA) for use in logging training.

The Guide Does Not Necessarily Reflect The Views Or Policies Of The U.S. Department of Labor, Nor Does Mention of Trade Names, Commercial Products, Or Organizations, Constitute An Endorsement Thereof.

In January 1998, New England was hit with an icing event which resulted in 700,000 acres of storm-damaged forest and roadside trees spread across 9 counties. The damage, mostly broken tops and bent over stems, created extremely hazardous conditions for those attempting to salvage timber and clear roadways.

TABLE OF CONTENTS

PAGE

Preface	I
Protecting Yourself and Others	1
Personal Protective Equipment	2
Lifting	4
Working in a Safe Environment	6
Environmental Conditions	8
Planning, Organizing, and Preparing the Jobsite	9
Maintaining The Chain Saw	11
Chain Saw Sharpening	14
Chain Saw Safety	19
Felling Trees	26
Felling Problem Trees	33
Limbing and Bucking	39
Limbing and Topping	39
Bucking at the Stump	44
Bucking at the Landing	44
Skidder Operations	46
Safety Instructions for Choker Setting	47
Safety Instructions for Skidders	48

	PAGE
Piling/Decking	50
Instructions for Knuckleboom	51
Equipment Maintenance	53
Maintaining the Skidder	54
Maintaining Piling Equipment	55
Causes of Fire	56
For More Information	61
Feller-Buncher Safety	59
Glossary	62

PROTECTING YOURSELF AND OTHERS

Equip Yourself And Wear The Appropriate **Personal Protective Equipment (PPE)** For Your Job:

Eye Protection
Head Protection
Hearing Protection
Hand Protection
Foot Protection
Leg Protection

- ✓ Handle and carry a chain saw in a manner that protects yourself and others from injury.
- ✓ Mount and dismount equipment using the three-point contact method in order to prevent personal injury.
- ✓ Recognize danger zones by keeping safe distances between others, equipment, and you, during cutting, skidding, decking (piling), and loading operations.
- ✓ Recognize the importance of proper lifting, carrying, and body positioning techniques to avoid back injuries.
- ✓ Recognize symptoms of potentially hazardous occupational diseases such as carpal tunnel syndrome, back injury, hearing loss, and Lyme disease. Understand benefits of **PPE** in relation to these diseases.

PERSONAL PROTECTIVE EQUIPMENT (PPE)

1. Safety helmets **must** be provided to and worn by everyone on the job.
2. Safety pants or chaps **must** be provided to and worn by workers using chain saws even if the use is only occasional.
3. Gloves or mitts **must** be provided to and worn by workers who handle wire rope and chain saws.
4. Safety goggles, safety glasses, or a face screen **must** be provided to and worn by workers when the possibility of eye injury is present.
5. Hearing protection **must** be provided to and used by workers who are exposed to excessive noise, e.g. chain saw operators and skidder operators.
6. OSHA-approved first aid kits **must** be provided to each work crew and be kept readily available.
7. Equipment operators **must** provide and wear waterproof heavy duty logging-style boots. **Chain saw operators must** provide and wear waterproof boots with lug or caulked soles, resistant to chain saw penetration.

NOTE: OSHA requires that items one through six be provided at no cost to the employee.

About That New Worker

Was The Worker ...

- 1) told to do the job?
- 2) shown how to do the job?
- 3) observed while doing the work?
- 4) corrected when activities are done unsafe?
- 5) commended for doing well?
- 6) warned of dangers?

Proper job instruction is real accident prevention! Remember that you were once a greenhorn - pass along your experience.

PERSONAL PROTECTIVE EQUIPMENT

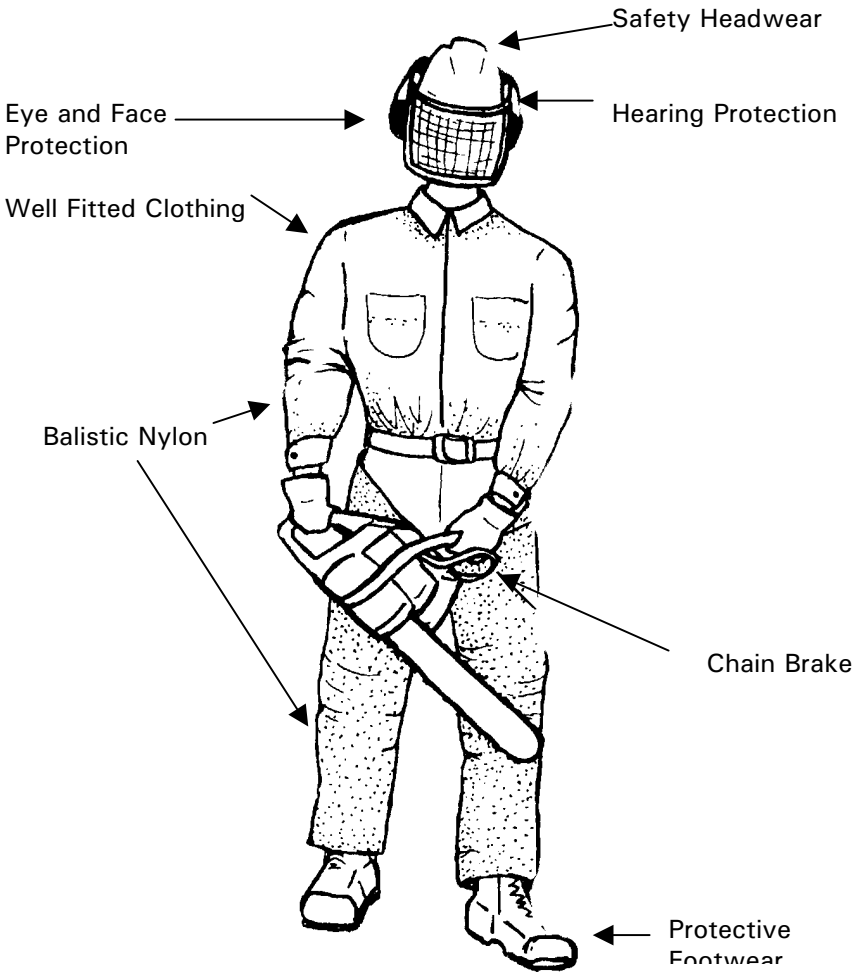

INCORRECT LIFTING

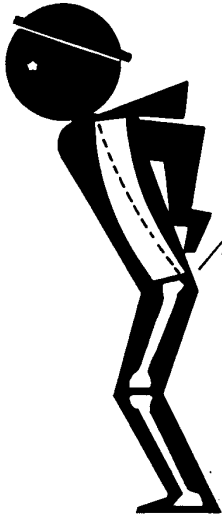

With back only

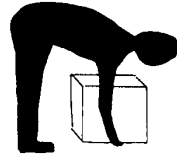

Twisting



High lifting

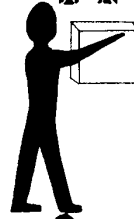

Load too bulky



Reaching over



CORRECT LIFTING



Lifting can hurt if done incorrectly. Protect your back by using your legs.



To lift, squat down with knees bent and back straight. Hold the load close to you.

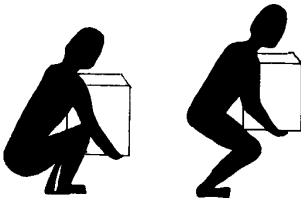

When doing high lifts, lift to waist height, change grip, bend knees, then push up with legs - this avoids body strain.



Be sure you can see where you are going. Get help with big loads.

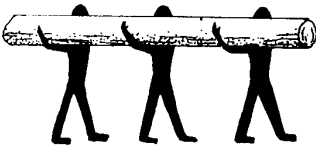

When team lifting, one man calls the signals and everyone works together.

ALWAYS LIFT GRADUALLY

WORKING IN A SAFE ENVIRONMENT

- Recognize the climatic extremes of wind, heat, cold, wet or dry environments, including their effect on cutting and skidding operations to ensure personal safety and efficient harvesting.
- Establish immediate site safety by eliminating problem trees such as: widow-makers, snags, spears, hang-ups, spring poles, and blowdowns.
- Recognize unstable ground conditions to minimize the effect on cutting and skidding operations and ensure personal safety and efficient harvesting.
- Identify and avoid contact with power lines and cables to ensure site safety.
- Identify, handle, and store hazardous materials such as motor fuel, lubricants, and cleaning solvent, etc., according to the manufacturer's specifications and your hazardous materials plan.
- Follow fire procedures according to company, state, and federal regulations.
- Work as a team member to ensure a safe and efficient operation. Team members must understand and use all company oral, written, and hand signals.

WORKING IN A SAFE ENVIRONMENT

WATCH FOR HUNG-UP TREES



Don't work near hung-up trees. Have these hazards pushed or pulled down by a machine.

ENVIRONMENTAL CONDITIONS

Weather Conditions

All work shall cease and employees shall move to a safe place during electrical storms, periods of high winds (15 MPH for chainsaw work) or other weather conditions that may be dangerous to personnel.

Danger Trees

Hazardous, dead, broken, or rotting trees shall be felled, removed, or avoided. No work will be done in the danger area until a hazard is removed. Set-back trees or hung-up trees shall be marked and removed promptly.

Trees shall be checked for hazardous snow or ice, and precautions taken.

When hazards exist and cannot be avoided, no work shall be done in the danger areas until the hazards are eliminated.

**PLANNING, ORGANIZING AND
PREPARING THE JOBSITE**

- Plan site layout by locating cut boundaries, terrain, and hazards, and determine cut methods to establish the landings, skid trails, and felling patterns.
- Identify hazards including widow-makers, snags, spears, hang-ups, spring poles, and blowdowns. Use chain saws or skidding equipment to clear the ground of underbrush and obstructions where necessary to provide safe access for efficient harvesting.
- Use proper equipment to prepare the landing and main skid trail to promote efficient cutting, skidding, and piling.
- Develop a felling pattern that provides safe access for efficient and productive harvesting by starting the harvest at a point determined by direction to landing, natural lean, terrain, and prevailing wind direction.

PREPARING TO FELL A TREE

STARTING A STRIP

Prepare to fell a tree by determining hazards such as the lean and soundness of the tree, and the speed and direction of the wind. Survey your work area and identify your escape route. Always notch the tree in the direction of fall and proceed with the correct cut for the circumstances.



MAINTAINING THE CHAIN SAW

- ***Clean the chain saw*** using proper techniques that ensure optimum performance and safe running condition according to the manufacturer's specifications.
- ***Inspect the chain saw*** for damage, loose screws, worn or defective parts, and proper spark arrester. Repair or replace parts as necessary according to the manufacturer's specifications.
- ***Check guards and safety equipment*** to ensure that they are in place and working.
- ***Fuel and lubricate the chain saw*** according to the manufacturer's specifications for personal protection, to reduce wear, and to ensure optimum and efficient performance. Be sure to use correct gas-to-oil ratio.
- ***Set proper chain tension*** by adjusting it according to manufacturer's specifications to protect the bar and chain from excessive wear and ensure optimum cutting.
- ***Clean and check bar*** regularly for straightness, deburr and dress rails, and lubricate according to the manufacturer's specifications for optimum performance.
- ***Sharpen the chain*** according to the manufacturer's specifications while wearing hand protection and using proper files, gauges, and guides, to ensure optimum cutting and to minimize kickbacks.
- ***Set the motor idle speed*** to ensure that the chain is stationary and the saw can idle.

MAINTAINING THE CHAIN SAW

- ***Start the chain saw with the chain brake engaged***, using one of two methods: 1) Hold the saw firmly on the ground with one hand on the top handlebar, and one foot holding the back handle. 2) The crotch-clamp technique is also acceptable. Secure the back handle of the saw between your legs while holding the top handle firmly.
- ***Test the chain brake*** to ensure that the chain will stop immediately if necessary.
- ***Operate the chain saw*** by keeping both hands on the saw to ensure safe operation and efficient cutting. Keep your thumbs wrapped around the handlebar.
- ***To provide optimum and safe felling***, maintain felling aids such as wedges, axes, and felling levers, by sharpening or replacing them when defective.

CHAIN SAW MAINTENANCE FOR SAFE AND EFFICIENT OPERATION

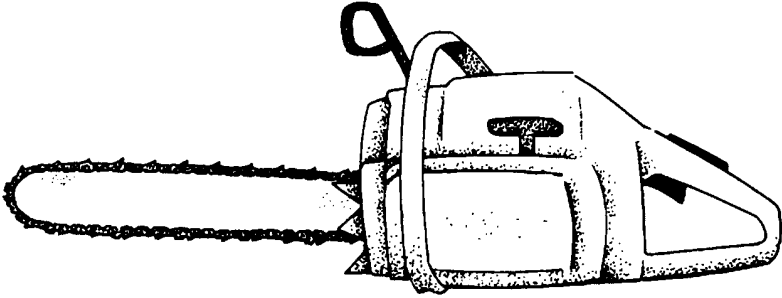

1. Keep Chains Sharp
2. Use Correct Depth Gauges
3. Keep Bar Grooves Clean And Dressed
4. Keep Proper Chain Tension
5. Use Proper Gas And Oil Mixture
6. Use Proper Chain Oil
7. Use Approved Safety Gas Cans
8. **Daily:**
 - Clean Sprocket Covers And Brake
 - Clean Air Filters
 - Check Nuts And Bolts
 - Check Sprockets
9. **Weekly:**
 - Clean Cylinder Fins
 - Fuel Filter
 - Check Spark Plugs

CHAIN SAW SHARPENING

Loggers are starting to take their saws, saw chain, and guide bars more seriously. They now realize the importance of reducing down-time and increasing productivity through proper maintenance.

By not properly sharpening your chain saw, you will reduce your productivity and increase your bar and chain wear, as well as causing yourself to fatigue.

In addition to the extreme importance of the health and safety factors, there are other considerations that are dependent upon good saw chain sharpening. One cost of operating any piece of equipment is maintenance. Always be concerned with the cost of repairs and replacements; they reduce your net profit which concerns everyone. Proper chain sharpening will increase the life of the chain, bars, power equipment, etc.

TYPES OF CHAINS AND THEIR USES

●Chipper, Micro-Bit Or Round Chain

Use whatever name you want, but all are very similar, if not identical. They are used mostly in .404" to 3/4" Pitch Chains for use with mechanical harvesters and are very popular for cutting hardwoods. These chains are ideal where severe conditions such as dirt and grit exist. In these conditions, dulling is very rapid with other types of chains. They are usually sharpened with a round file or grinder.

●Semi-Chisel Or Micro-Chisel

This chain has a flat top plate and flat side plate with a definite rounded corner at the intersection of these surfaces. This chain type is used more in general applications where cutting

conditions are fairly severe but not extreme. Sharpen with a round file or grinder.

- **Chisel-Type Chain** This chain has a flat top plate and flat side plate with a sharp corner at the intersection of these two surfaces. It is used where production is a prime consideration. This chain is an excellent cutter when used in more ideal tree conditions, and is a favorite of more timber fellers. Best results are produced when cutters are square-ground with a square file or an appropriate grinder.

The previously-mentioned types of chains come with cutters spaced as follows:

1. **STANDARD** (full comp) sequence - one tie strap is positioned between each cutter, alternating right and left, using two drive links for each cutter.



2. **SEMI-SKIP** sequence - cutters alternately have one tie strap between the right and left-handed cutters, then two tie straps between the next right and left cutters, then one tie strap, etc.



3. **FULL-SKIP** sequence - provides two tie straps between each alternating right and left cutter, each supported by three drive links.



Not all chain types are available in the previous sequences; check your dealer for availability. Quite often there will be anti-kick or safety devices installed ahead of the depth gauge incorporated with the tie strap.

The sequence of the cutter position is mostly a personal preference of the saw operator. The standard type provides a smoother cut with less chance of vibration and kick-back, and a good all-around felling, limbing and bucking chain.

Most chains are available in different driver gauges. Standard chains most commonly used are provided in .050", .058", and .063" thicknesses. Some .404" gauge harvester chains are available in .080" gauges while the 3/4" pitch chain is standard at .122" thick on the drivers for obvious reasons.

Depth gauge settings are usually specified by the chain manufacturer and sometimes are stamped on the depth gauge. Their recommendations are generally accepted by the operator.

SAW CHAIN SHARPENING ANGLES

Sharpening the saw chain cutters not only requires sharp edges; the angles at which the three (3) surfaces are ground or filed is also of the utmost importance. The surfaces are generally referred to as:

TOP PLATE ANGLE



TOP PLATE CHISEL ANGLE

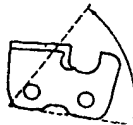

SIDE PLATE ANGLE

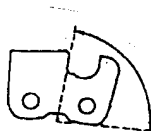

All degrees referred to are given from either the base of the chain or from the side of the chain. The slope of the side or top of the cutter is not a reference point, as these surfaces are angular in themselves.

There are two methods of sharpening chains. The most common method of sharpening is with a hand-held round file. This style, in most cases, will have available file holders and other tools that can help stabilize and provide better accuracy and uniformity to the sharpening operation. The other method of sharpening is by using a grinder equipped with a rotating stone pulled down into the cutter's cutting edge while the cutter is secured in a vise-like rail to hold the cutter in the proper grinding position. This type of grinder is more expensive.

Loggers should follow the chain manufacturer's recommended angle specifications whether using the round file method or a mechanical grinder. Check for the latest information because angular specifications have, in some cases, changed radically in recent years. These changes have been developed in the field and, as a result, the chain performance is much better.

CHISEL BIT CHAIN (SQUARE FILING)

This saw chain is not for everyone. A chisel-bit saw chain is a professionally-classed saw chain. Before using any professional class of saw chain the operator **MUST** be instructed in advanced cutting and maintenance procedures. The reactive forces produced may be higher than low-kick saw chains

CHAIN SAW SHARPENING

The reduced-resistance cutting ability of chisel-bit chains shows noticeably increased cutting speed and smoothness in most wood types. Many loggers are getting excellent results with chisel-bit chains even in dirty wood. They are reducing sharpening frequency compared to that needed on round-ground chisel chains. Users are reducing the top plate angle to decrease the tooth's side movement. The angle iron effect of the channel cut to the point on chisel-bit chains offers the point more support from the underside. This effect decreases the possibility of the point deforming during abrasive conditions.

The round tooth saw chain has many variables: The file size and location, the possibility of hooking the tooth, and the importance of the top angles. With chisel bit filing, the angles are simplified and the file size is the same on all tooth sizes.

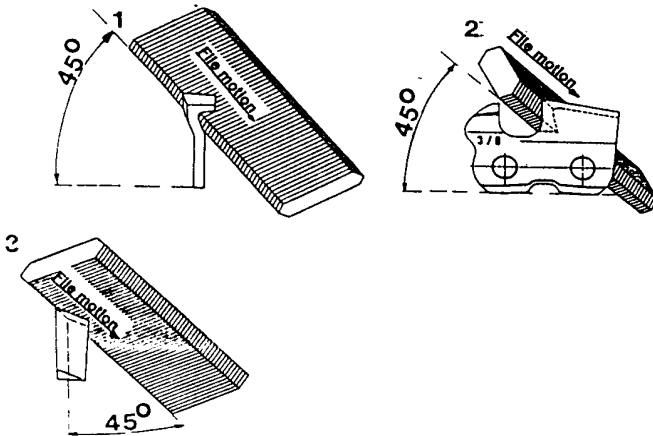

CHAIN SAW SAFETY

SAFETY DEVICES

1. All chain saws should have the following mechanical safety features:
 - a. Chain brakes
 - b. Vibration-dampened handle system
 - c. Throttle interlock to prevent accidental engine acceleration
 - d. Chain catcher near clutch housing and throttle handguard
 - e. **Safety features shall not be altered, rendered inoperable, or removed**

2. Accessory safety equipment for chain saw operators:
 - a. Approved safety fuel can
 - b. Appropriate tools to maintain the chain and powerhead
 - c. Two plastic, wood, or aluminum alloy wedges and (felling) bar
 - d. An axe with a blade guard
 - e. Personal first aid kit

3. Miscellaneous equipment for efficient use of power saws:
 - a. Funnel for fuel and oil
 - b. Extra files and gauges for sharpening the chain
 - c. Spare saw parts to minimize downtime:
 - (1) Spare chain and sprocket
 - (2) Extra guide bar nuts
 - (3) Extra spark plug
 - (4) Extra air filter
 - (5) Extra starter rope and spring
 - (6) Extra chain catcher, spare bar, and bar tip
 - (7) Extra saw wrench
 - d. Fire extinguisher

OPERATING PROCEDURES

1. Chain saws are involved in more than 50 percent of all woods accidents and should be handled with caution.
2. Hard hats, eye and ear protection, appropriate footwear, and safety pants or chaps shall be worn by saw operators. See page six for a complete list.
3. Always start the saw on flat, level ground, or by using the crotch clamp method; never drop-start or use your knee.
4. When carrying the saw any distance, carry it by the front handle with the motor stopped and the bar to the rear so it can be thrown clear in case of a stumble or fall.
5. Adjust the idling screw so the chain stops and the saw idles for several minutes. Follow the manufacturer's specifications for adjustments.
6. Let the motor cool before refueling. Refuel a minimum of 20 feet from a flame source.
7. Wipe gasoline spills off the motor.
8. Keep a first aid kit and fire extinguisher handy.
9. Keep your thumbs fully encircled but not tight around the handlebars, not resting on top of the handlebars.
10. Hold the saw with your wrists as straight as possible and keep the bar and chain on a plane that is not in line with your body.
11. Stagger your feet in a way that provides for good balance in case of a kickback. Always keep your knees bent and your back straight.

STARTING YOUR SAW

Never Start A Saw On Your Knee Or By Drop-Starting.

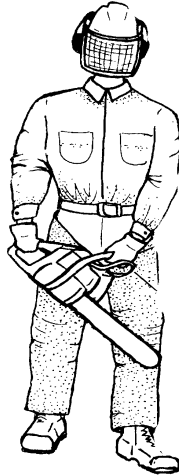

**Always Start Your Saw
On Smooth, Level Ground,
Or By Using The Crotch
Clamp Method.**

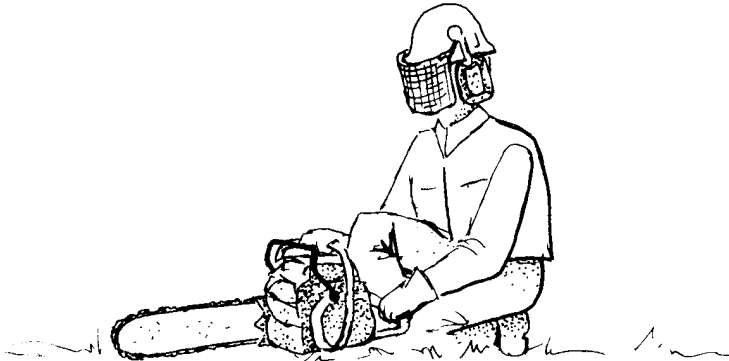

CHAIN SAW KICKBACK

Most chain saw injuries are caused by kickback. Kickback occurs when the kickback corner of the bar strikes an object. To prevent kickback, make certain the tip of the bar is clear for all normal cuts. Make bore cuts using the attack corner of the bar. Start the cut with the lower quadrant of the bar until the wood is on both sides of the tip. Then straighten it out and complete the bore cut. Take a very firm grip on the saw using extreme caution to counteract any kickback reaction.

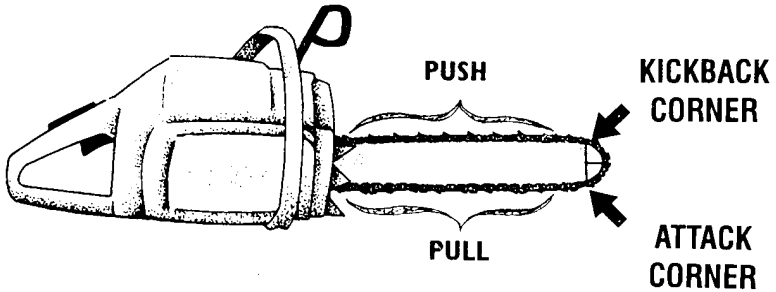

FOUR CAUSES OF KICKBACK

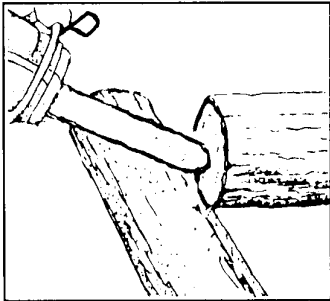

1. The kickback corner of the bar hits an obstruction.

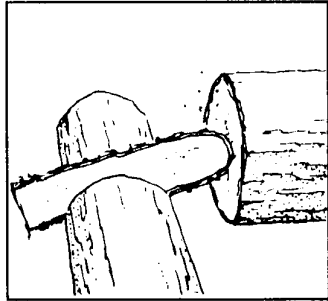

2. The cutting teeth on the chain

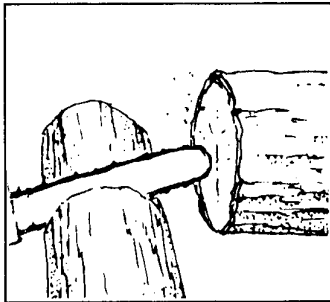

3. The chain piles up at the point of contact.

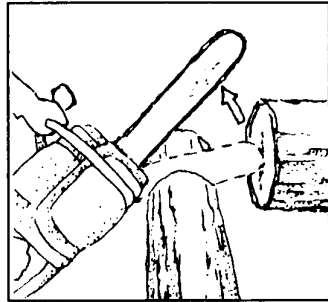

4. Drive force kicks the bar carrying the chain upward in a direction opposite to that in which the chain is being

CHAIN SAW ACCIDENTS

Average Body Contact with Moving Chain
Hitting Points (Average %)

14

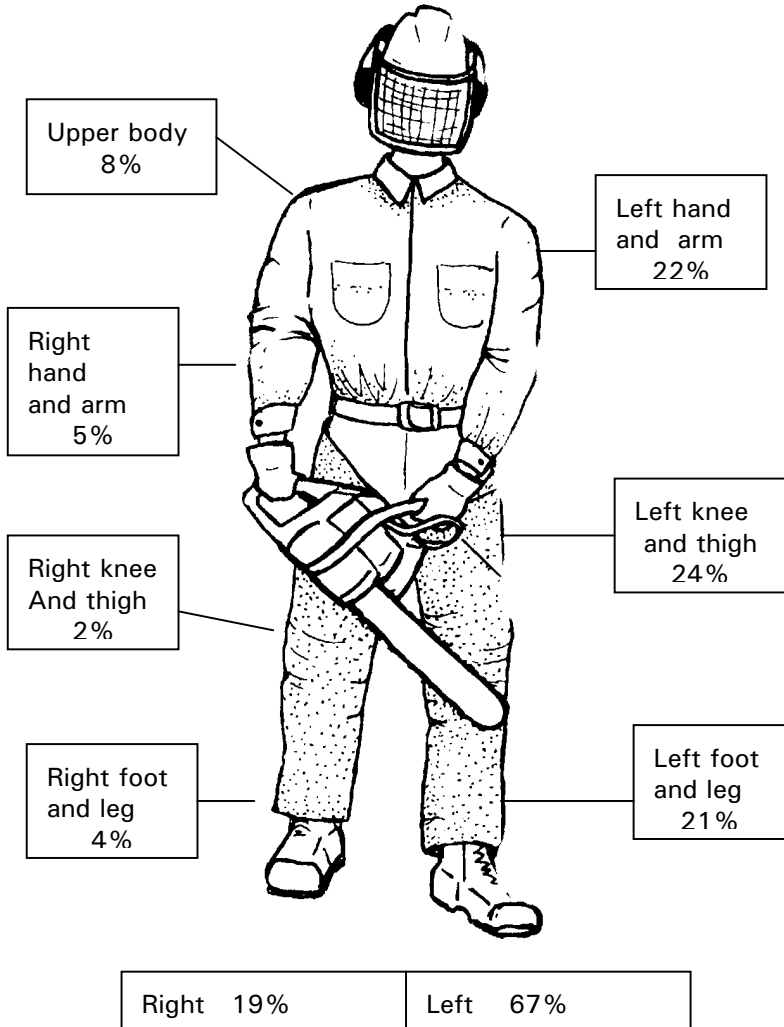

KEEP SAW PROPERLY ADJUSTED

Always keep your fingers back on the handle, not on the trigger. Otherwise, if you fall, you may automatically grab the trigger, causing a serious or fatal injury.

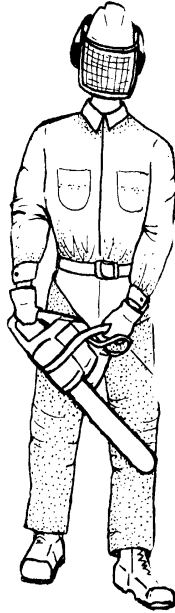

Never carry a saw with a running chain...shut it off or engage the chain brake when carrying for distances greater than 50 feet, or for lesser distances when the terrain and other physical factors make the carrying of a running saw hazardous.

S E T C H A I N B R A K E !!

***TAKE YOUR FINGERS OFF THE SAW TRIGGER
WHEN MOVING FROM TREE TO TREE.***

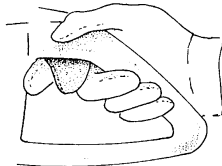

FELLING TREES

Determine and develop a safe and efficient felling pattern from visual observation. Take into account such factors as landing area, wind direction, natural lean of trees, and terrain.

Prior to felling trees, identify and eliminate hazards in the felling area such as: widow-makers, snags, spears, hang-ups, spring poles, blowdowns, and unstable ground. This safety check will optimize safety and production.

Observe felling danger zones by keeping a safe distance (two tree lengths or more if necessary) between yourself, others, and equipment.

Prepare the felling area by clearing debris and obstacles from the base of the tree, establishing an escape route, and eliminating potential hazards.

Cut a notch using the "open face" or "undercut" method as described in the **OSHA LOGGING** Standard 29 cfr 1910.266 (g) (2) (iii), making the selection based on tree species, size, lean, location, and safety. Develop a felling pattern to facilitate safe, efficient production.

After giving a warning understood by all personnel, make the appropriate back cut. The back cut on an open face notch should be at the **SAME** level as the notch. Establish the proper hinge wood (length approximately 80% of diameter breast height (DBH), width, approximately 10% DBH) so that direction of fall is controlled and any potential butt kickback is minimized.

Retreat from a falling tree by using an established escape route 45 degrees to the rear of the intended direction of fall while keeping the tree in view. Establish - Safe side and Hazard side so that you put yourself on the safe side during felling phase of backcut escape to safe side.

PROPER TIMBER FELLING PROCEDURES

1. Cut down all dead snags or stubs first.
2. Always look at the top of the tree for widow-makers, lodged trees, wires, and other hazards. Plan the direction for the fall of the tree. Clear an area around the tree before starting to cut.
3. Prepare a line of retreat 45° away from the line of fall. Be sure you are not hemmed in with underbrush or obstructions.
4. Before starting to cut, make sure no one is closer than two tree lengths away from felling operations.
5. Make a notch on all trees no matter how small the diameter.
6. Give a timely warning yell understood by all employees, just before the back or final cut is started.
7. Never cut a standing tree completely through. Leave sufficient wood between the notch and the back cut for the tree to hinge on; otherwise, you may lose control of the tree and it could kick back.
8. Never leave a lodged or hung tree; always push or pull it down with the aid of a skidder, etc. If it has to be left unattended for any length of time, properly mark it to indicate a danger area.
9. Never cut on days of high wind velocity.
10. Never climb or cut sections out of lodged trees.
11. Never leave a lodged tree, as any vibration from machinery or a sudden wind could bring it down on a crew member or an unsuspecting person.
12. Fell with the lean of the tree whenever possible, and into clear areas.
13. Retreat from a falling tree at a 45° angle away from the direction of fall and at least 20 feet from the tree. If possible, stand behind another tree at the end of your retreat path.

**PROPER FELLING IMPROVES QUALITY, QUANTITY,
AND SAFETY BY REDUCING:**

- ✓ The number of trees falling in the wrong direction
- ✓ Pulled fibers and side scars
- ✓ Damage to the butt log
- ✓ The amount of time spent moving wood to the landing
- ✓ Time spent pushing and pulling trees down
- ✓ Time lost when a chain saw is pinched
- ✓ Injuries from pushing and cutting at the same time
- ✓ The possibility of a tree splitting in a barber chair
- ✓ The number of tree butts kicking back off the stump
- ✓ The possibility of trees being cut almost completely off and not falling

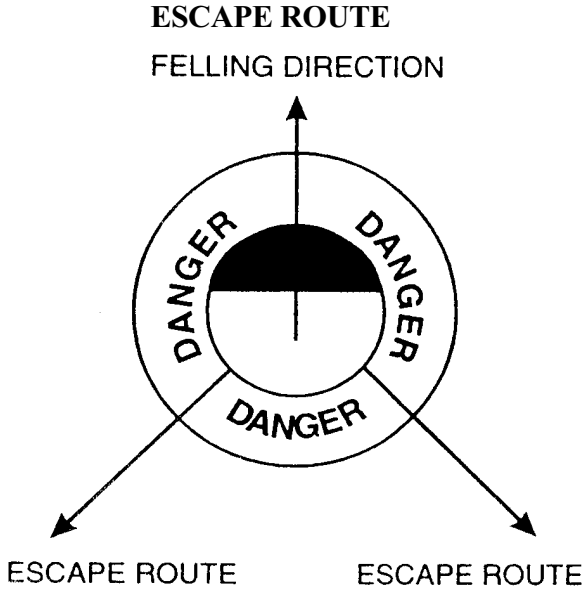

The escape route shall be at a 45° angle away from the falling tree to a distance of at least 20 feet away from the tree.

PROPER NOTCHES

Conventional

V-Notch
Open-face - 70° or more

Humboldt

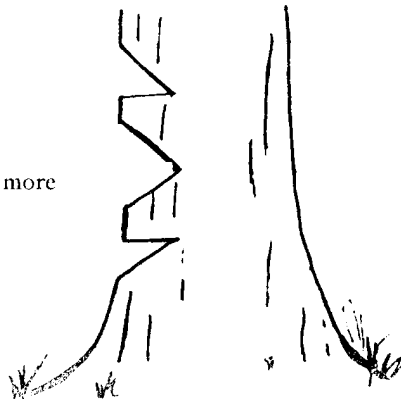

PROPER DIMENSIONS OF NOTCHES

The depth of the notch should be $\frac{1}{3}$ of the tree diameter. The face opening of a notch "A" should be equal to the depth "B."

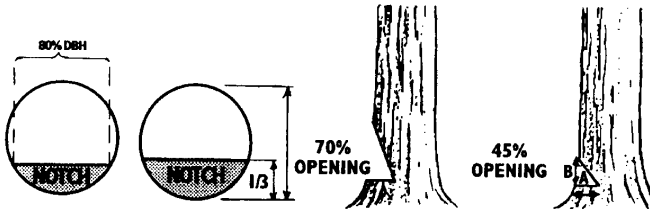

A wide-open face notch is safest, and requires an opening of 70° or more to prevent premature closing of the notch.

THREE TYPICAL IMPROPER NOTCHES

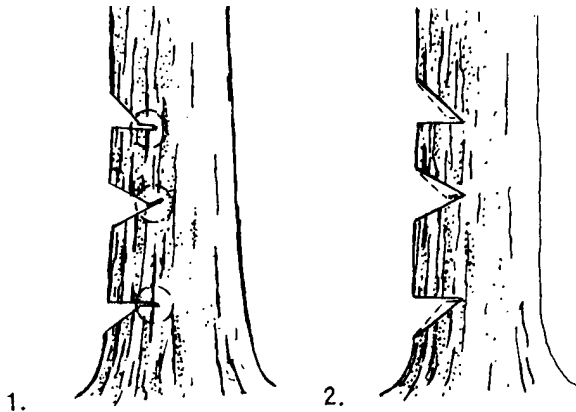

1. Improper notches
2. Portion of notch that must be removed to correct the improper cut

PROPER BACK CUTTING

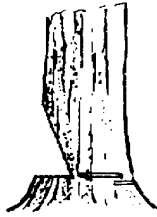

**OPEN FACE NOTCH
BACK CUT SAME LEVEL
AS NOTCH**

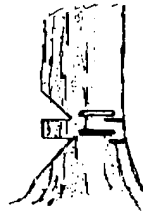

**CONVENTIONAL & HUMBOLDT
BACK CUT NOTCH
SLIGHTLY ABOVE NOTCH**

OPEN-FACE NOTCH (70° OR MORE)

Bore cut to establish a hinge and cut toward the back of the tree. Stop the cut leaving enough holding wood on the back side of the tree. Then, release the tree from the back side with a cut below the bore cut.

Hinge or holding wood of sufficient length and width is required to control the tree when falling. The bore (back) cut must be made at the same level as the notch to increase hinge strength. This technique is considered the safest method to fell trees.

RESULTS OF IMPROPER BACK CUTTING

1. Back cut too deep (inadequate hinge)

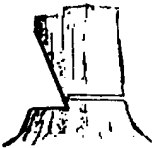

The hinge will break almost immediately, resulting in inaccurate felling and damage to the bar or saw.

2. Back cut too high above the notch



This highly increases the chance the hinge will break, allowing loss of control of the felling of the tree. It also produces a low quality butt.

3. Back cut below the notch



The same problems exist with this technique as with cutting above the notch. Bypassing the cutting of the notch will reduce hingewood strength and will allow the tree to freefall without control.

4. Sloping back cut



This cut lessens the chance of meeting the notch or leaves an inaccurate hinge producing low quality butt.

5. Angle-back cut with inadequate notch



With no notch directional felling is greatly reduced. This cut produces loss of felling control, low quality butt, and greatly increases the chance of barber chairing.

FELLING PROBLEM TREES

Some trees present special problems in felling:

1. Trees that side scar easily (such as ash)
2. Larger trees - light leaners or heavy tops
3. Heavy leaners
4. Felling trees against the natural lean



NOTE

Several of the following techniques may or may not require shallow side-cutting at the corners of the notch when cutting grade logs. Side-cutting is used on leaners to stop barber chairing and is often used on straight-grained trees such as oak and ash. *Side-cutting of log timber is a must!* This procedure will help reduce side scarring and fiber pull of the butt log; however, it also will reduce the strength of the holding wood or hinge.

***ALL OF THESE TECHNIQUES
REQUIRE
ADVANCED ABILITIES***

TREES THAT SIDE SCAR EASILY

To prevent side scarring in standard felling, the sides of the hinge between the notch and the back cut are sawn before making the back cut.

As the tree falls, the stronger, more flexible fibers do not break when the notch closes.

Instead of breaking with the hinge, strips along the side of the tree rip off the butt log, resulting in side scars.

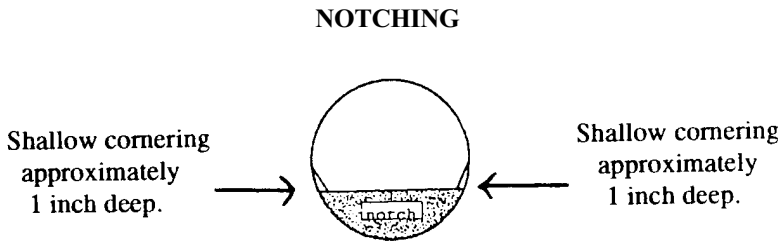

Method To Use When The Tree Diameter Is Greater Than The Length Of The Chain Saw Bar, But Not More Than Twice The Length Of The Bar

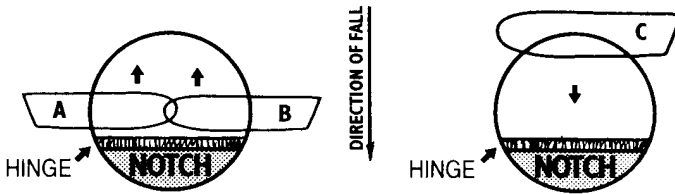

BORING TECHNIQUE

1. The notch is made in the normal manner and the boring cut is **begun using the lower quadrant of the bar tip** starting on the side with the lean of the tree.
2. Once the wood is on both sides of the bar tip, the saw is straightened and the bore is completed just beyond the halfway point of the tree's diameter. This action will allow an overlap when the bore cut is completed from the opposite side of the tree.
3. If the tree has a heavy forward lean, bore in from both sides to establish the hinge. Then cut to the back leaving support wood. Pull the saw out, then release the tree from the backside.



If boring is done incorrectly there is an increased chance of kickback; **use extreme caution.**

CAUTION

When using this technique, the saw needs to be running at maximum RPM's and the chain needs to be properly sharpened. Professional training is advised so that this technique can be properly utilized.

**Method To Use When The Tree Diameter Is Greater Than Two Times
The Chain Saw Bar Length**

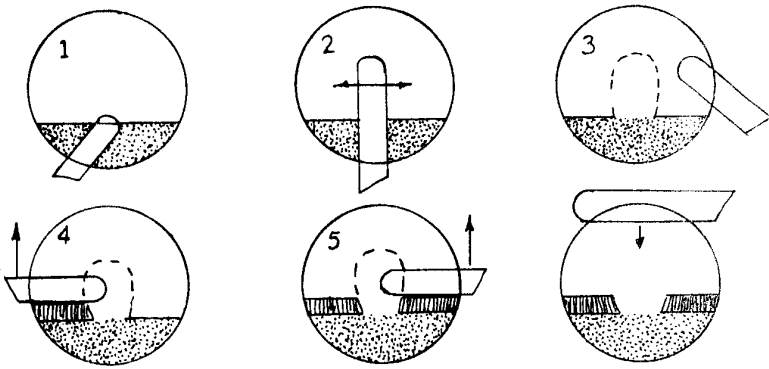

BORING TECHNIQUE

1. The notch is made in the normal manner. A **bore cut is made in the center of the notch using the lower quadrant of the bar tip.**
2. Cut out as much wood as needed so the bar will reach from both sides. Remove the saw.
3. Start a bore cut at the normal level for a back cut, again using the lower quadrant of the bar.
4. Bore straight in, leaving enough hinge wood for the size of the tree. Walk the saw around, cutting approximately half the tree. Repeat the procedure on the opposite side, leaving sufficient holding wood in back.
5. Use a release cut from the back side.

CAUTION

This is a very professional type of felling! A large diameter tree may be left standing until a cutter can use a larger saw with a longer bar. Again, professional training is recommended for this technique.

HEAVY LEANERS

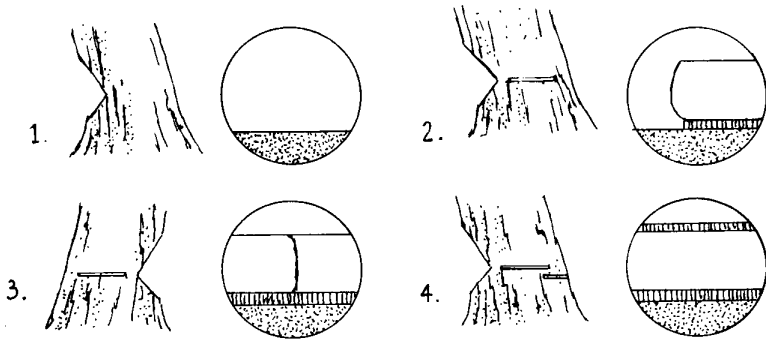

BORING TECHNIQUES

!!! CAUTION !!!
This is a very professional type of felling. If you are not comfortable cutting these trees--DON'T DO IT!

1. Begin by making an open-face notch (70° or more); hinge length should be 80% DBH (or longer if necessary). For example, a 10" DBH tree should have a hinge length of at least 8".
2. At the same plane as the notch, bore out the tree from the hinge wood back, while leaving sufficient holding wood at the back of the tree. Always start boring with the lower part of the bar tip. This is considered the safest felling technique.
3. The same boring procedure is then performed on the other side of the tree, ensuring that the two boring cuts meet. Omit this step if the tree is small enough for the saw bar to reach through the tree in one cut.
4. A final horizontal back-cut is made below the boring cut. The holding wood at the back severs and the tree falls, guided by the hinge. Always start boring with the lower part of the bar tip.

FELLING AGAINST THE NATURAL LEAN

A large tree may be felled against its natural lean by using the boring technique. Use the open-face notch and bore cut the tree to establish the hinge. **DO NOT CUT OUT THE BACK.** Allow enough backwood to keep the tree secure. Remove the saw from the bore cut and insert wedges tightly into it. Release the tree from the back. Complete the technique by wedging the tree over. *This technique is for experienced cutters only.*

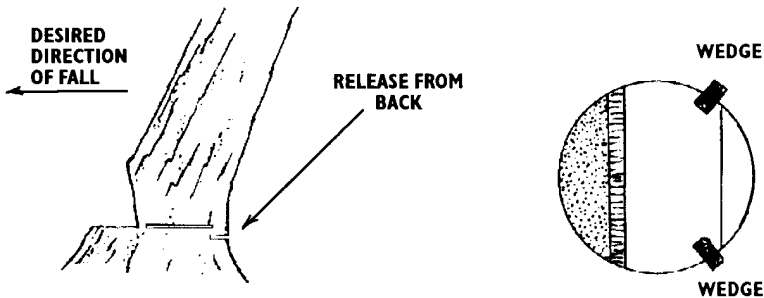

Felling against the natural lean may be necessary to:

- Avoid falling into other trees
- Place the tree in the desired direction
- Prevent a hang-up
- Avoid breakage
- Avoid disturbing the felling pattern
- Avoid falling on fences, across property lines, etc.

LIMBING AND BUCKING

LIMBING AND TOPPING TREES

1. Identify hazards such as spring poles, compression and tension stress points, holes, and hanging limbs and/or tops. Chain saws and skidding equipment or related tools can minimize or eliminate problems such as saw kickback, limb/tree/springpole kickback, and tree roll.
2. Move back into the felling area to begin limbing and topping only after all debris produced by the falling tree is settled, and all potential hazards are eliminated.
3. Cut limbs and tops from felled trees using balanced footing, body position, and safe saw handling methods in accordance with utilization standards.

SAFETY INSTRUCTIONS FOR LIMBING

1. Make sure your footing is sound; keep your balance.
2. Start limbing from the butt end of the tree and work toward the top.
3. Always stay on the uphill side of the tree.
4. Always limb from the ground; do not walk on the tree.
5. When possible, stand with your feet in the clear, and limb from the left side of the tree.
6. Make sure the saw bar is on the opposite side of the tree before moving forward. Do not move when the saw is on your side of the tree.
7. To prevent kickbacks, do not limb with the kickback corner of the saw. Make sure the saw is at full speed before cutting a limb.
8. Carefully cut spring poles from the underside to relieve the tension first, then cut it off.
9. Cut supporting limbs last using extreme caution as the log may roll.
10. Use the top of the bar when possible to avoid cutting toward your feet and legs.

11. When cutting large limbs, be alert for the chain binding and kicking back. Use the limb lock technique.
12. Keep a minimum of two tree lengths away from the feller and falling trees.
13. When cutting limbs under tension, use a limb lock technique. Relieve pressure on the limb by making the first cut on the tension side. The second cut should slightly bypass the first cut, allowing the limb to lock into itself. (See diagram below.)

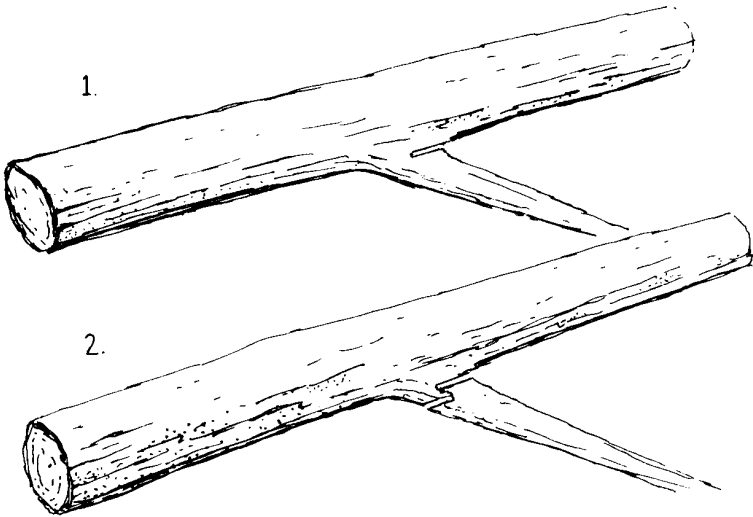

TECHNIQUE FOR SAFELY CUTTING SPRINGPOLES

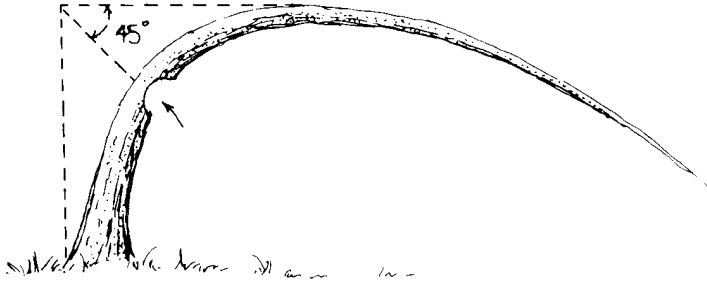

The safest way to release a springpole is to shave a sufficient amount of wood from the underside of the springpole to allow the wood fiber on the top side to release slowly.

To decide optimum point of springpole release, determine a straight vertical line from the stump to where it meets a straight horizontal line from the highest point of bend, and come down at a 45E angle from where the two lines intersect.

**WORK IN THE MOST
COMFORTABLE POSITION POSSIBLE**

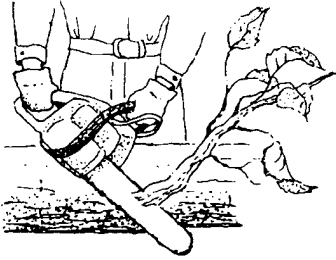
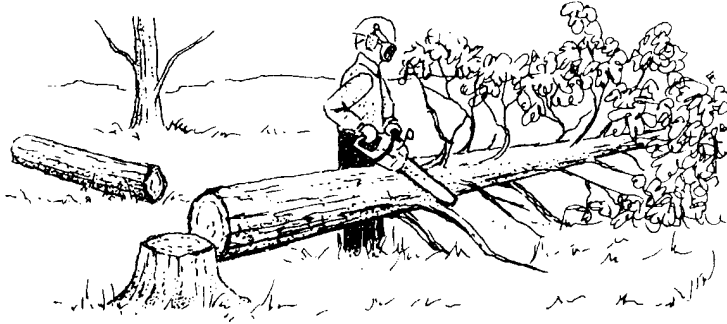

Maintain a firm stance close
And hold the saw close to
your body.

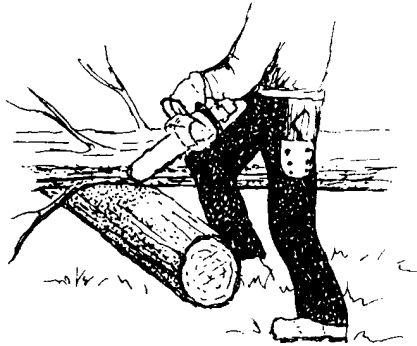

When possible, let the saw ride the trunk. Do not move your feet when the running saw is on your side of the trunk. Use the chain brake when moving over the tree or log.

ADDITIONAL TECHNIQUES FOR LIMBING AND TOPPING

TOP LOCK TECHNIQUE

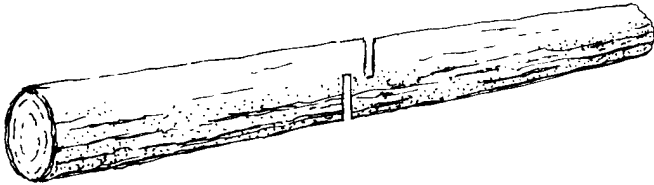

A top lock will prevent the top of the tree from kicking up and hitting the logger. The first cut is made on the compression side of the tree; the second cut is made on the tension side of the tree. The first cut is always made closest to the tree top; the second cut is made closer to the butt. Both cuts must bypass each other (see diagram).

TONGUE AND GROOVE TECHNIQUE

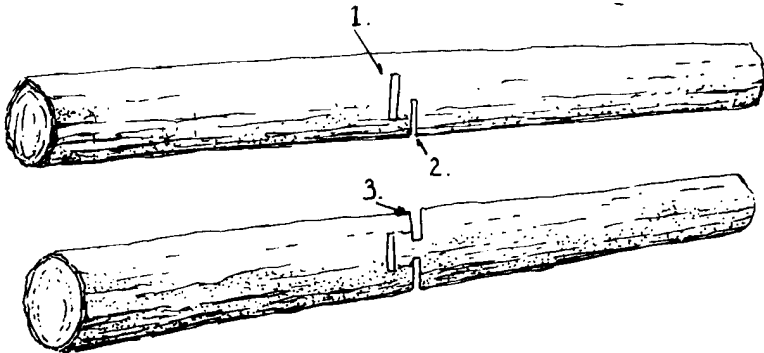

On steep terrain, prevent the tree from rolling by using a tongue and groove technique. First, bore through the center of the tree. Make the second cut on the compression side of the tree slightly bypassing the bore cut. The third cut is made on the opposite side of the tree in line with the second cut and slightly bypassing the first cut. This technique will prevent the tree from rolling and will separate when skidded.

BUCKING AT THE STUMP

1. Observe danger zones before bucking. Resolve potential problems such as spring poles, compression and tension stress points, terrain, potential direction of roll of log, and hanging limbs and tops. Establish an escape route. Use saws and related tools safely and efficiently.
2. Measure and mark logs to an appropriate length while considering ease of handling and further processing according to production requirement.
3. Before cutting logs or sticks consider the tree's stress points to properly place your feet and body. Use the correct saw handling methods to buck safely and efficiently according to your production requirements.

BUCKING AT THE LANDING

1. Observe danger zones before bucking. Resolve potential problems such as stress points, slippery footing, foreign objects in the pile (rocks/dirt) and in the log (nails, wire fencing, etc.), potential direction of log roll, and the possibility for a chain saw kickback.
2. Measure and mark log lengths after considering quality and production requirements. Establish an escape route.
3. Before cutting logs consider log pile compression and tension stress points to properly place feet and body. Cut logs using proper footing and body techniques as dictated by log pile compression and tension stress points, and by using saw handling methods for safe and efficient log production. A wedge will keep the cut open to avoid saw pinching.

SAFETY INSTRUCTIONS FOR BUCKING

1. Plan your cuts before starting the saw.
2. Work from the butt to the top of the tree. Work on the ground; never walk on a tree.
3. Avoid using the extreme tip of the saw for bucking to avoid kickback.
4. Only start the undercut first when the log is supported on one end. When the log is supported on two ends, you should begin with the top cut.
5. On large logs, hold the saw head against your thigh to avoid losing control if it kicks back.
6. Use a wedge to prevent binding when bucking logs.
7. Watch out for binding of the saw and possible kickback.
8. Keep the saw out of dirt and rocks.
9. Work on the uphill side if possible. If a tree is in a dangerous position, have it moved.
10. Stand with your legs at shoulder width and braced to maintain secure footing and balance. Keep as secure a footing as possible. Avoid an off-balance position where you can lose control of your saw. Bend your knees.
11. Never leave a log partially cut.
12. Make sure the chain is not turning while walking to the next cut. Keep your finger off the throttle when walking between cuts. Use the chain brake or shut the saw off when moving 50 feet or more, or when shorter distances require it.
13. Keep a minimum of two tree lengths away from fellers, and a safe distance from all other operations.
14. Keep the saw chain sharp, depth gauges correct, and the chain properly tensioned.
15. Let the saw cut through the log--don't force it.

SKIDDER OPERATIONS

1. Keep a safe distance between ground workers and other equipment in danger zones.
2. Groom the site constantly by using empty skidding equipment to push down widow-makers, spears, hang-ups, spring poles and blowdowns, and to break trails to facilitate safe, efficient skidding.
3. **Remove Spears Immediately!**
4. Position the machine at felled trees to winch straight in for safe, efficient transport.
5. When preparing to hook a skid, set the brake, secure the blade on the skidder, release the winch, and pull the mainline and chokers. You may use other related methods to prevent personal injury while efficiently and safely winching logs.
6. Use the three-point technique (one hand and two feet or two hands and one foot) to dismount the machine.
7. Use chokers as close to the butt of the tree or log as is practical for efficient production and to prevent damage and personal injury.
8. Use safe and correct methods to move the loaded skidder to the landing. Observe the correct speed for the terrain. Minimize damage to residual stands and potential dangers to yourself and others.
9. Release wood at the landing at the proper time and predetermined position to promote safe and efficient unloading.
10. Use safe and correct wood piling methods at the landing to promote efficient processing.

SAFETY INSTRUCTIONS FOR CHOKER SETTING

1. Direct your skidder operator with established signals when moving or stopping the machine.
2. Always wear gloves when setting chokers. Watch for frayed cable.
3. If you are setting your own chokers, make sure your brakes are on and the blade is down before leaving your machine.
4. Always operate the skidder's or tractor's winch from the driver's seat, never from the ground.
5. Always set chokers from the butt end unless there is a reason to skid the top first. Never set a choker in the middle of a log.
6. If the release chokers are hung up in the skid, let the skidder pull them loose. Stay clear in case they snap.
7. Stay clear of cables under tension.
8. Visually inspect cable and chokers daily for broken strands or cuts.
9. Stay clear of logs that might roll and watch out for unexpected cable or chain movement.
10. Stay behind and to the side of moving loads; never ride it.
11. Watch out for your hands and fingers when releasing chokers; they could get pinched if the logs should roll.

**SAFETY INSTRUCTIONS FOR RUBBER-TIRED
SKIDDERS OR PREHAULERS**

GENERAL SKIDDING

1. Wear a hard hat, safety boots, gloves, and eye and ear protection.
2. Only trained and authorized personnel should operate skidders.
3. Keep a first aid kit, fire extinguisher, and operator manual on the skidder.
4. Keep hands, feet, and clothing a safe distance from moving parts.
5. Keep steps free from oil, mud, grease, and ice.
6. **Do Not Have Riders;** your skidder is a one-man vehicle.
7. Seat belts shall be installed and worn.
8. Use the three-point mounting/dismounting method - one hand and two feet, or one foot and two hands.

OPERATION OF A SKIDDER

1. Drive slowly over rough terrain or down steep grades.
2. Don't leave the skidder while it is moving.
3. Don't drag the empty main line on the ground.
4. Don't winch at severe angles.
5. Don't skid across a steep slope; always skid up or down a slope.
6. On steep-sided hills, avoid abrupt uphill turns. Back downhill, then go straight uphill.
7. If it is necessary to park on a hill, set the brake and drop the blade. Use a tree or high stump for added bracing.
8. Reduce speed when turning.
9. Drive at a safe speed.
10. Raise the skidder blade when traveling and lower the blade when dismounting the machine.
11. Observe the area before backing up.

SKIDDER OPERATION

12. Use a lower gear when descending steep hills or lower the load to help in braking. Don't use the brakes--you may lose control.
13. Slow down and keep track of your load and other workers when approaching or turning on the landing.
14. Before traveling, winch your load up close to the skidder with butts off the ground to prevent hang-ups and rollovers.
15. If logs bind against stump or rock, reposition machine or unhook. Don't go in and try to cut stump **or** don't keep pulling, especially if others are in the area.

**Operators Shall Not Exceed Manufacturer's
Recommendations In The Operation Of Skidders!**

PILING/DECKING OF WOOD PRODUCTS

- ✓ Observe danger zones by keeping a safe distance between you, others, and adjacent piles.

- ✓ Initially groom the site to level the piling area. Remove widow-makers, hang-ups, spring poles, and blowdowns from the piling area. Groom the site during piling to keep the area clear of brush and debris.





- ✓ Position piles to allow safe access of machinery. Keep the pile level and uniform to eliminate protrusions from the pile face. Ensure that decks or piles have products placed in a position that minimizes rolling and shifting, or causing decks/piles to break down.

- ✓ Position machinery to allow safe piling. Keep the pile height within operating capabilities of piling and loading equipment. Ensure that decks or piles have wood placed in a position to minimize rolling, shifting, or pile break downs.

SAFETY INSTRUCTIONS FOR KNUCKLE-BOOM LOADERS

1. Inspect the machine and clear the work area of personnel before starting.
2. Your loader is designed for lifting and loading; don't allow it to be used for anything else.
3. If equipped with stabilizers, lower them on a firm footing before doing any work with the loader.
4. Observe the work area before starting work and while loading; there may be people or objects in your work area. All truck drivers shall be a safe distance in front of and off to one side of the loading operations, and in view of the operator at all times. Hard hats are required by all operators.
5. Never let anyone get under your boom or load.
6. When working near power lines, keep a clearance of 10 feet if the voltage is 50 Kv or below. For each one Kv over 50 Kv, add an additional four inches. If the operator cannot maintain the required clearance by visual means, a person must be designated to observe and give timely warning if violation of the clearances might occur.
7. Before dismounting, lower the boom onto the boom rest or the ground.
8. Before traveling, lower and secure the boom, raise the stabilizers, disengage the pump, and secure any payload.
9. Know all the clearance dimensions for your forwarder. Check them against clearance requirements along your route of transport.
10. Be aware of blind spots from the operator's seat.

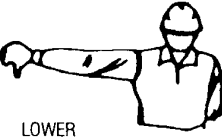
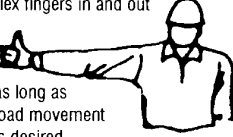
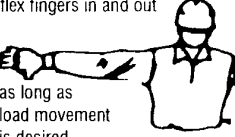
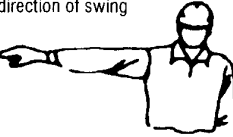
HAND SIGNALS FOR BOOM EQUIPMENT OPERATION

 <p style="text-align: center;">RAISE LOAD SLOWLY</p>	 <p style="text-align: center;">LOWER LOAD SLOWLY</p>	 <p style="text-align: center;">RAISE BOOM</p>
 <p style="text-align: center;">LOWER BOOM</p>	<p>RAISE BOOM AND LOWER LOAD Extend thumb upward and flex fingers in and out</p>  <p>as long as load movement is desired.</p>	<p>LOWER BOOM AND RAISE LOAD Extend thumb downward and flex fingers in and out</p>  <p>as long as load movement is desired.</p>
<p>SWING - Extend arm with forefinger indicating direction of swing</p> 	<p>STOP - Extend forearm and hand in horizontal position and make slicing motion.</p> 	<p>EMERGENCY STOP</p> 

POWER LINE CLEARANCES

Avoid all live overhead electrical distribution or transmission lines until the line has been visibly grounded and the owner of the utility indicates the area is safe. When a line cannot be de-energized, check your state's regulations and recommendations for safe clearance.

EQUIPMENT MAINTENANCE

All too often, machinery reaches a state of disrepair. This is not only dangerous to the operator, but also is a financial loss to the owner. This loss can be avoided by daily care, checks on the equipment, and replacing parts before injury or loss occurs. Some items, however small, can cause disabling injuries and loss time. Many hazards are created by ignoring seemingly innocent situations such as control levers without knobs.

All heavy equipment has safety features to protect the operator; do not take them for granted. Check all hydraulic systems daily for leaks that might cause a slow blade, poor steering, or poor braking action. Check all screens daily for disrepair; they protect you from branches, logs, lying debris, and cable whip. Make sure all windows are clean. A few moments of your time spent in a safety check for defects can ensure you and your employer a profitable and accident-free working day.

MACHINERY MAINTENANCE CHECKS

1. Visual - All fluid levels; check for leaks.
2. Visual - Loose nuts, bolts, cracks, hoses, pins, and damage.
3. Visual - Tires for pressure, damage, and lug bolt tightness.
4. Visual - All cable rigging or booms for damage.
5. Visual - Equipment free of debris.
6. Visual - Fire extinguisher and first aid kit.
7. Visual - Check for vandalism.
8. Check all gauges to be sure they are working properly.
9. Be sure all steps and platforms are free of oil and debris.

MAINTAINING THE SKIDDER

1. Conduct a daily circle check before operating skidding equipment. These checks should include: tires/tracks, engine, hydraulics, and winch and cable rigging for frays and condition. Also check related equipment for fluid levels, leaks, loose wheel nuts, bolts, and cracks and damage. These checks spot present or potential damage that jeopardize safe and efficient equipment operation.
2. Follow manufacturer's procedures for starting equipment to reduce maintenance and optimize safe operation.
3. Perform operational checks while seated in the operator's position. With the engine running and maximum visibility, check gauges and move controls manually to ensure all parts of the skidding equipment are working according to the manufacturer's specifications.
4. Before moving equipment conduct a visual inspection of the area to ensure that no one is in the operator's path.
5. Ensure personal safety by lowering and deactivating powered equipment such as buckets, blades, grapples, clams, and forks. Set hand brakes using correct procedures when leaving skidding equipment unattended.
6. Perform shutdown procedures according to manufacturer's specifications. Immobilizing unattended skidding equipment by lowering the blade will prevent accidental movement. Turn off master switch to avoid electrical shorting.
7. Maintain equipment by lubricating according to manufacturer's specifications. Clear all debris from the engine, manifold, brake, winch, radiator, and other areas of equipment to prevent fire and spot problems or equipment malfunctions.
8. Always keep proper records; fill out daily reports.

MAINTAINING PILING EQUIPMENT

1. Conduct a daily circle check before operating piling equipment. Check tires/tracks, engine, and hydraulics. Also inspect related equipment for fluid levels, leaks, loose wheel nuts, bolts, cracks, and damage. This will help spot present or potential damage before skidding operations begin. It also will optimize safe and efficient operation of equipment.
2. Start piling equipment following manufacturer's procedures to reduce maintenance and optimize safe, smooth operation.
3. Perform operational checks while seated in the operator's position. With the engine running and maximum visibility, check gauges and move controls manually to ensure all parts of the piling equipment are working according to the manufacturer's specifications.
4. Before moving equipment conduct a visual inspection of the area to ensure that no one is in the operator's path.
5. Lower and deactivate powered equipment such as clams, grapples, and forks. When leaving the equipment unattended, set hand brakes to ensure personal safety.
6. Perform shutdown procedures according to manufacturer's specifications. Immobilize unattended piling equipment by lowering grapples, clams, or forks to secure against accidental movement. Turn off the master switch to prevent electrical shorting.
7. Help maintain piling equipment by lubricating according to manufacturer's specifications. Clear all debris from piling equipment to prevent jamming and to spot developing problems or equipment malfunctions.
8. Always keep proper records; fill out daily reports.

CAUSES OF FIRE

ELECTRICAL

Surveys have shown that one-third of the fires investigated started because of short circuits; damaged wiring is often the cause. Wiring and battery cables are subject to unusual wear. Wiring insulation can become abraded or torn, causing short circuits. This condition, combined with accumulations of oil and fuel-soaked debris, can cause a fire.

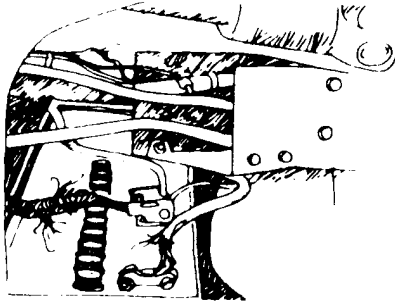

BRAKES

Another cause of fire is overheated brakes. Skidders are equipped with a parking or auxiliary brake which can be used to hold the skidder stationary. If the operator travels with the brake engaged, it will overheat. If not detected in time, this can cause a fire.

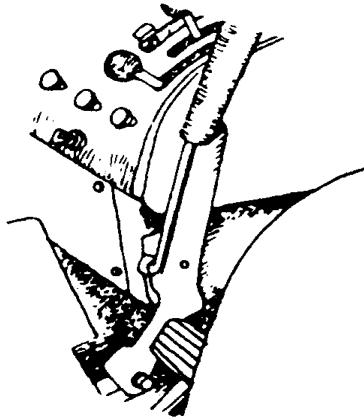

ENGINE AREA

Another cause of fire is flammable material coming in contact with hot engine parts. Housekeeping is the key to prevention in this type of fire. Newly purchased woods equipment is relatively safe from fire, but when working in the forest, it's impossible to prevent small particles of dry leaves, needles, branches, and twigs from building up in tight corners of the machine. All debris must be removed daily.



Debris, fuel, and oil are most likely to accumulate in the lower portions of the front frame assembly and transmission compartment.

FIRE PREVENTION GUIDELINES

- ✓ Keep the engine compartment clean
- ✓ Stop leaks and inspect the electrical system
- ✓ Stop the engine while fueling, and **No Smoking**
- ✓ Maintain a charged fire extinguisher
- ✓ Remove oil, twigs, and debris daily

FIRE EXTINGUISHERS

Fire extinguishers should be provided on each job site and on each piece of mobile equipment. They also should be the proper type and size for the situation.

Fuel should be stored in an approved container and kept in a safe place.

FUEL STORAGE

1. Keep only what's necessary. Large amounts may require a storage permit...check with the Fire Department.
2. Store outside if possible, or in a well-ventilated area free of ignition sources (no smoking).
3. Store in approved safety cans.
4. Post a "NO SMOKING" sign.

*The Secret to fire control is the three steps that make a fire.
Skip A Step And Stop A Fire!*

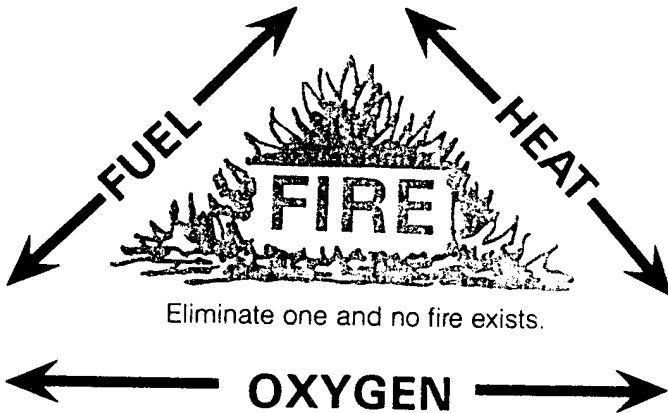

FELLER-BUNCHER SAFETY

1. Check all hydraulic lines and fittings, the hydraulic fluid level, and the motor oil level, before operating.
2. Check for vandalism before operating.
3. Check all pins and the carrier's lift arm linkage before operating.
4. Never start the carrier until everyone is completely clear of the shear.
5. Do not make any adjustments or repairs to the shear while the carrier is running or the operator is in the carrier's cab.
6. Never leave the shear unattended while the carrier is running.
7. Never leave a tree in the shear unattended.
8. Never elevate the shear to work on it unless it is supported.
9. Never elevate an unattended shear.
10. Do not attempt to shear trees larger than the shear's rated capacity.
11. Do not allow anyone within two tree lengths while the shear is in operation.
12. Do not use the shear for a "dozer" blade.
13. When working on an incline, do not work around the slope. Work uphill and deadhead downhill; the machine is more stable this way. As a general rule, a 35:1 slope is the recommended maximum for safe operations.
14. After shearing the tree, carry it low. Carrying a tree high can tip the machine and cause severe damage to the boom or loader arms.
15. Make gradual motions with the machine while holding a tree. Quick moves may cause tops to break off and fall on the cab.

16. Don't pile trees in bundles larger than skidders can handle.
17. Only trained and authorized personnel should operate equipment.
18. Keep the manufacturer's operator's manual with the equipment at all times.
19. Do not exceed the manufacturer's recommendations.



Carrying trees up or down a slope calls for special care. When carrying trees downhill, tilt the shear head back so that the tree is leaning back over the machine. When carrying trees uphill, tilt the shear head out so that the tree leans away from the machine.



FOR MORE INFORMATION

For more information on logging safety, contact:

NH Timber Harvesting Council	603-224-9699
American Pulpwood Association	207-622-3705
Occupational Safety & Health Assoc.	603-225-1629
University of New Hampshire Cooperative Extension	603-862-1028
University of New Hampshire - Thompson School of Applied Sciences	603-862-1103

Logging equipment manufacturers also can supply your company with information about logging safety, machinery maintenance, and equipment operation.

GLOSSARY

BACKCUT: The final cut in felling a tree. It is made on the side opposite the notch and direction of fall.

BALLISTIC NYLON: A fabric of high tensile properties designed to provide protection from lacerations.

BARBER CHAIR: A tree which splits up from the back cut, instead of breaking to the undercut.

BIND OR BOUND: The compression created by a cut in a tree or log due to uneven terrain or contact pressure from other trees or logs.

BINDER: A chain, nylon strap, or wire rope used to bind a load of logs.

BORE CUT: A technique used to establish a hinge.

BORING: Beginning a cut using the attack section of the tip of the bar allowing the chain to cut through a log or tree.

BUCK: To saw felled trees into shorter lengths.

BUDDY SYSTEM: The procedure in which two workers are always within sight and/or sound of each other.

CABLE: A woven wire rope. In logging, a wire rope is generally termed a "line."

CALKED BOOTS: Boots containing steel calks or spikes in the heel and soles.

CHAIN BRAKE: A safety device which stops the saw chain.

CHAIN SAW: A saw powered by an engine or motor in which the cutting elements are on a circular chain.

CHOKER: A short length of wire rope used to attach logs to a main line. It is provided with a sliding hook and a ferrule at either or both ends.

COLD DECK: A number of logs piled or decked for storage or for handling purposes. It is known as a "**Hot Deck**" when logs are taken from it before the deck is completed.

CUTTER (Feller, Bucker): One who fells, bucks, or limbs trees.

DANGER TREE: A standing live or dead tree, including snags, with evidence of deterioration or physical damage to the root system, trunk, or stem. The degree and direction of lean is also an important factor when determining if a tree is dangerous.

DIRECTIONAL FELLING: A felling technique to control the direction of fall of a tree.

ESCAPE ROUTE: A preplanned and brushed out escape route used by fellers to make their way into the clear when the back-cut is completed.

FALLER: A worker who fells trees for logging purposes. Usually he/she also is a buckler.

FELL (cut): Process of severing a tree from the stump so that it drops to the ground.

FELLERS: Workers who cut down trees.

FOPS: Falling Object Protective Structure.

GUARD: Any protective device around a machine or danger zone.

HAZARD: A condition in which risk is involved.

HINGE: The wood which controls the tree as it falls to the ground.

GLOSSARY

HOLDING WOOD: The appropriate amount of wood left at the back of the tree to hold the tree stable until ready for release.

HOT DECK: A landing where logs are constantly being moved.

KERF: The width of any saw cut.

KICKBACK: Strong thrust of the saw back toward the cutter, generally resulting from improper use of the saw. Kickback also refers to a tree jumping back over the stump toward the cutter.

KNUCKLEBOOM: A hydraulic loader.

LANDING: A term used to indicate a place where logs are hauled, piled, stored, or dumped.

LIMB: To remove the limbs from a felled tree.

LODGED TREE: Tree that has not fallen to the ground after being partially or wholly separated from the stump or otherwise dislodged from its natural position.

LOG: Tree segment suitable for subsequent processing into lumber, pulpwood, or other wood products.

LOGGER: Anyone engaged in preparing trees and transporting them to the sawmill. (Clerks, cooks, and other persons involved in a logging operation, but not actually engaged in handling the trees, are **not** considered loggers.)

LOGGING: All operations relating to the felling of trees, cutting felled trees into suitable lengths, yarding, limbing, debarking, grading, loading, hauling, unloading, and storing in decks until transformed from timber to wood products.

LOGGING MACHINE: A machine used or intended for use to yard, move or handle logs, trees, chunks, earthen material, and related material or equipment.

NOTCH: A wedge-shaped cutout which creates the opening for the tree to fall into. It also controls direction of fall.

PPE (Personal Protective Equipment): The specific OSHA-accepted items of protective clothing worn by loggers.

PULPWOOD: Wood cut or prepared for use by a pulp mill.

ROOT WAD: Mass of roots and dirt which projects above the ground level after a tree has been blown or pushed over.

ROPS: Rollover Protective System or Structure.

SAW DOGS: The metal plate containing three to five points in front of the chain saw housing, protruding parallel with the bar. They act as a pivot point for the saw during cutting.

SAW LOG: The sections of a tree of suitable character and length for handling in a sawmill and for use as lumber.

SELECTIVE LOGGING: *Choosing* trees in a certain area for logging purposes.

SET BACK: Occurs when a tree settles back opposite to the intended direction of a fall. This creates a hazardous situation when the logger loses control of a tree.

SKID: To drag logs or haul trees from the stump to a landing.

SKIDDER: A track unit or rubber-tired machine which transports logs to a designated landing.

SNAG: A dead standing tree. Also, a broken-off tree or branch of a tree.

SPRINGPOLE: Tree or branch that is under tension.

3- (THREE) POINT TECHNIQUE: Using two hands and one foot, or two feet and one hand when mounting or dismounting a piece.